

Outline Dimensions

V1200 1400 1600 2000

Unit: mm

V-1600

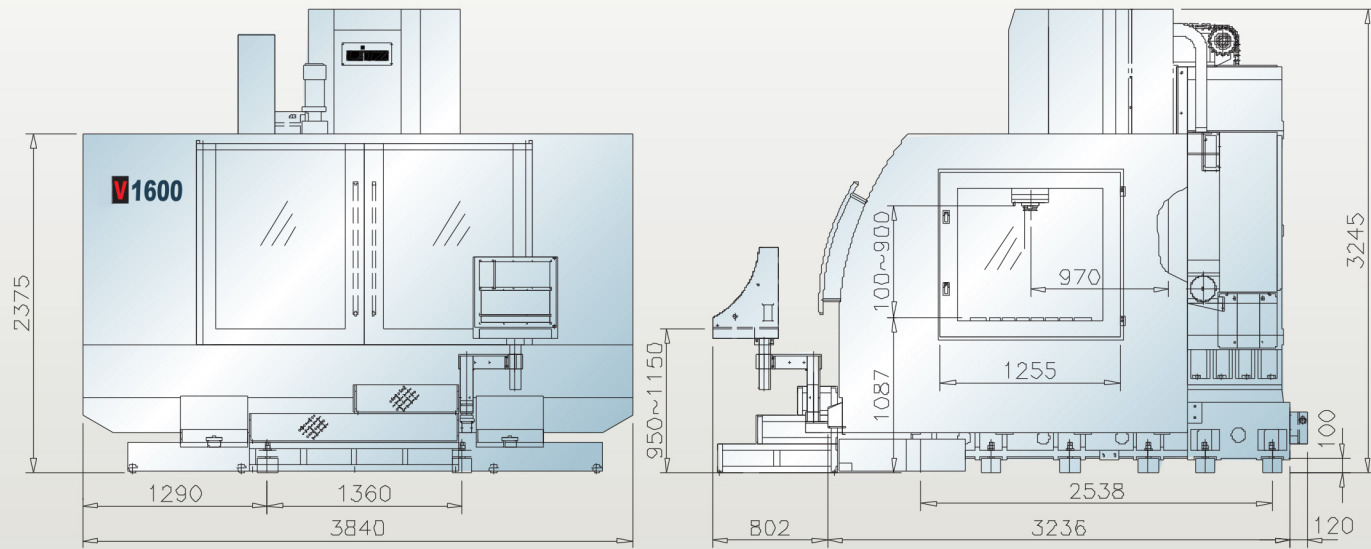

V-2000

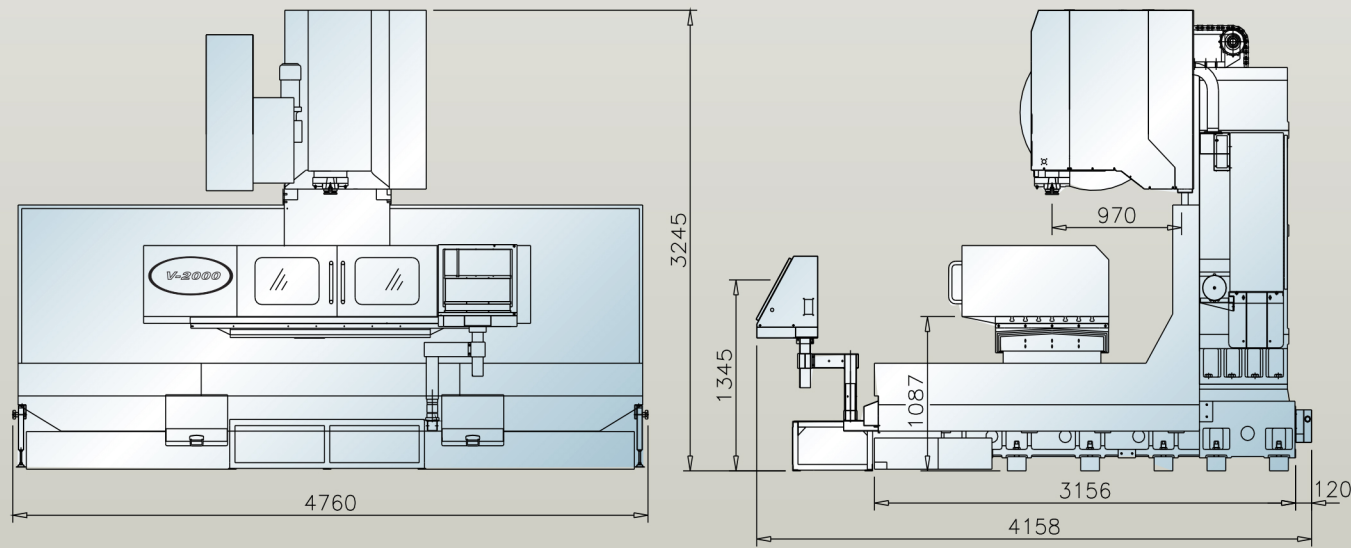

Worktable Dimensions

V1200 1400 1600 2000

Unit: mm

V-1200

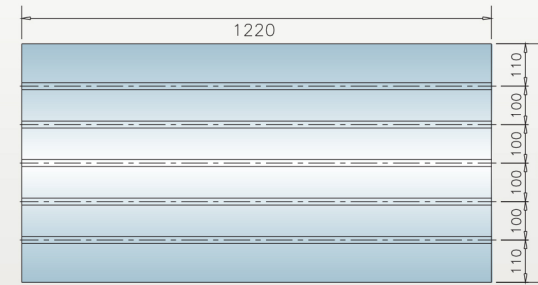

V-1200 T-Slot dimensions

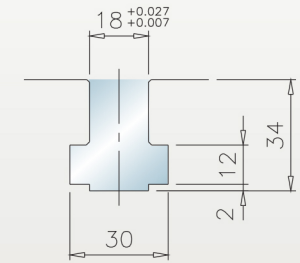

V-1400N

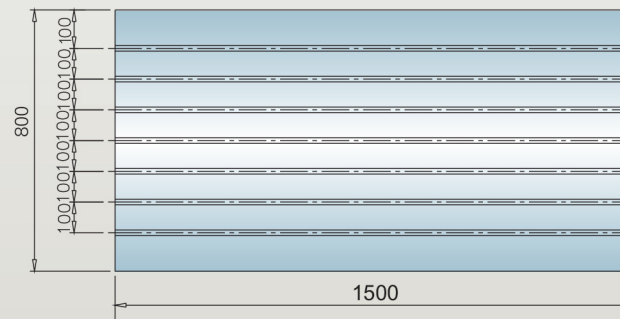

V-1400N T-Slot dimensions

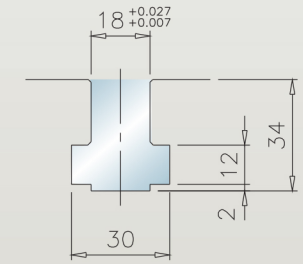

V-1600

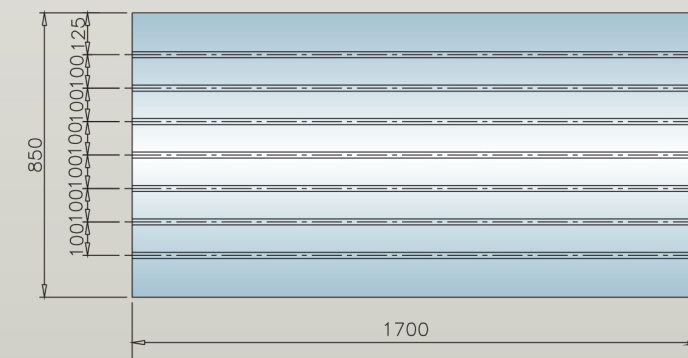

V-1600 T-Slot dimensions

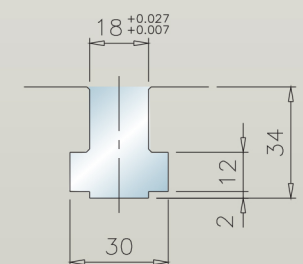

V-2000

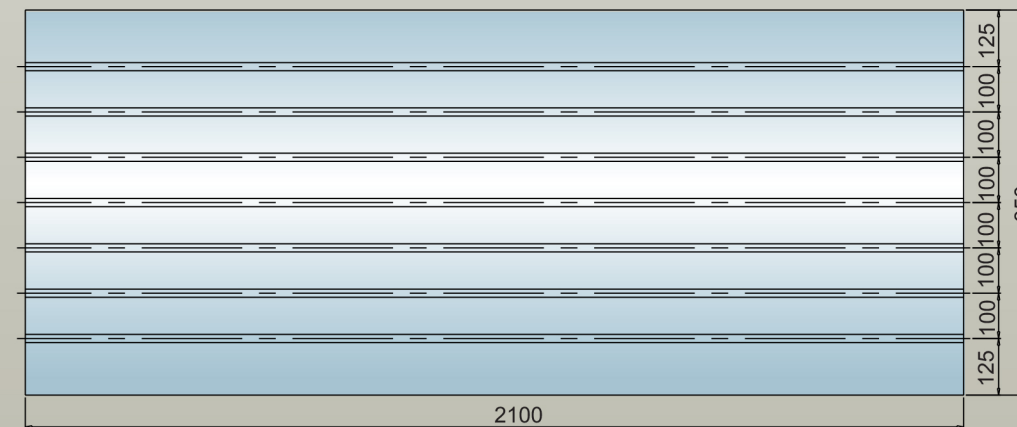

V-2000 T-Slot dimensions

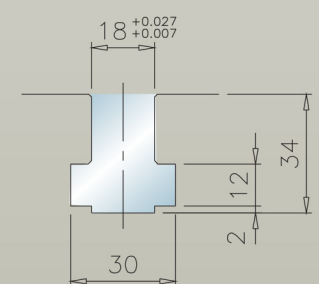

26

27

Tool Shank and Pull Stud

BT-40

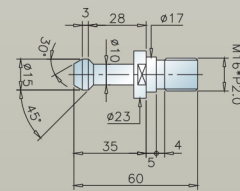
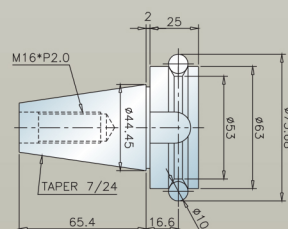

BT-50

